









No.	86 03 180
EAN	4003773035466
Esecuzione	cromata
Manici	rivestiti in resina sintetica
B1	5,0 mm
B2	8,0 mm
B3	12,0 mm
Regolazioni	13
 Per dadi apertura	1 3/8 Pollici
 Per dadi apertura	35 mm
 Lunghezza	180 mm
 Peso netto	254 g

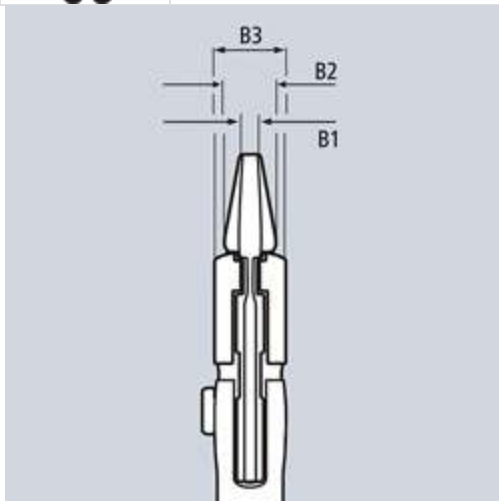

No.	86 03 250
EAN	4003773033837
Esecuzione	cromata
Manici	rivestiti in resina sintetica
B1	8,0 mm
B2	8,0 mm
B3	14,0 mm
Regolazioni	17
 Per dadi apertura	1 3/4 Pollici
 Per dadi apertura	46 mm
 Lunghezza	250 mm
 Peso netto	536 g

