

NEW OLYMPIC

PIATTO DOCCIA QUADRATO O RETTANGOLARE



OPTIONAL



Piletta di scarico
ø 90 non fornita

Codice	Prezzo
PIL90PCAB-CR40	

Per una ottimale tenuta si consiglia l'uso della nostra piletta di scarico **PIL90PCAB-CR40**, oppure di pilette di scarico dotate di guarnizione a doppio labbro

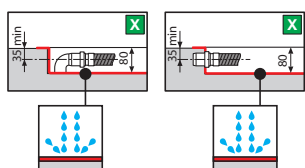
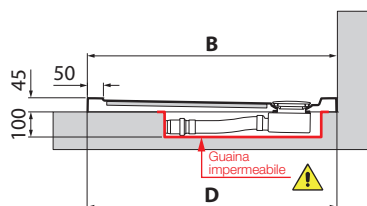
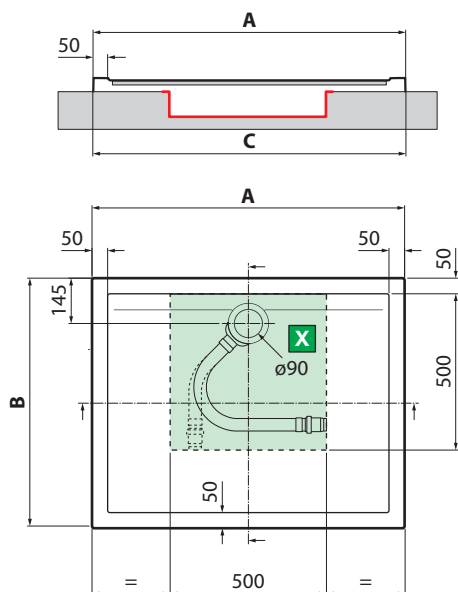

NEW OLYMPIC

SPESORE 4,5 CM

Misure			Codice	Scelta finitura Prezzo	
A x B ± 2 mm		C x D ± 3 mm		30	79
				Bianco	Bianco morbido
80 x 80	794 x 794	796 x 796	OLN 80 4-		
90 x 70	894 x 694	896 x 696	OLN 9070 4-		
90 x 75	894 x 744	896 x 746	OLN 9075 4-		
90 x 90	894 x 894	896 x 896	OLN 90 4-		
100 x 70	994 x 694	996 x 696	OLN100704-		
100 x 80	994 x 794	996 x 796	OLN100804-		
100 x 100	994 x 994	996 x 996	OLN 100 4-		
120 x 80	1194 x 794	1196 x 796	OLN120804-		
120 x 90	1194 x 894	1196 x 896	OLN120904-		

ESEMPIO COMPILAZIONE CODICE:

OLN804-30 = OLN804- + 30



* Profilo di rinforzo in metallo

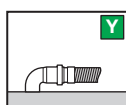
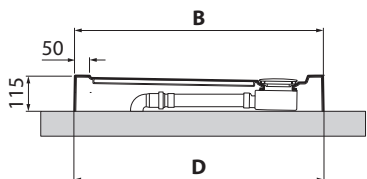
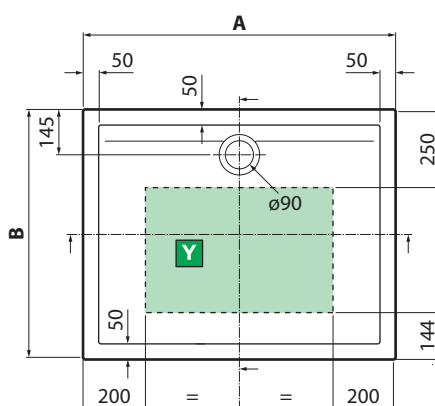
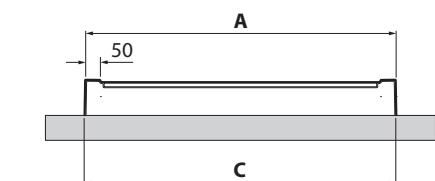

NEW OLYMPIC

SPESORE 11,5 CM

Misure			Codice	Scelta finitura Prezzo	
A x B ± 2 mm		C x D ± 4 mm		30	79
				Bianco	Bianco morbido
80 x 80	794 x 794	798 x 798	OLN 80 11-		
90 x 70	894 x 694	898 x 698	OLN 9070 11-		
90 x 75	894 x 744	898 x 748	OLN 9075 11-		
90 x 90	894 x 894	898 x 898	OLN 90 11-		
100 x 70	994 x 694	998 x 698	OLN10070 11-		
100 x 80	994 x 794	998 x 798	OLN10080 11-		
100 x 100	994 x 994	998 x 998	OLN 100 11-		
120 x 80	1194 x 794	1198 x 798	OLN12080 11-		
120 x 90	1194 x 894	1198 x 898	OLN12090 11-		

ESEMPIO COMPILAZIONE CODICE:

OLN8011-30 = OLN8011- + 30

X Zona incassata a pavimento per lo scarico H 100

Y Zona disponibile per lo scarico sopra pavimento

• Disponibilità indicativa deposito centrale 7gg.

PIATTI DOCCIA