

YOUNG 2.0

Design minimal e lineare dal semplice mantenimento.

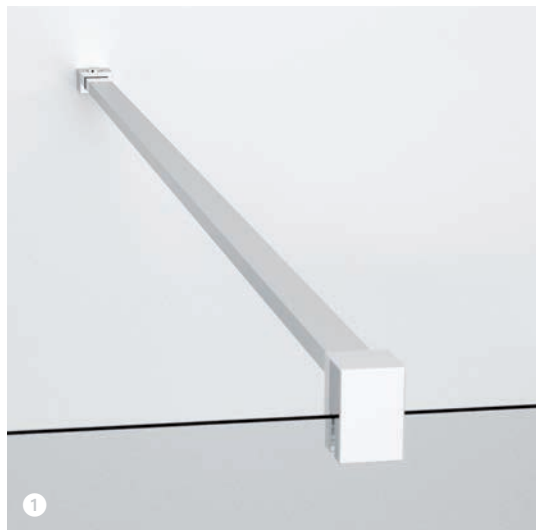

- 1 Nuova barra di sostegno a muro. 2 Maniglia in metallo cromato.
3 Doppia cerniera di sollevamento, porte reversibili. 4 Possibilità di apertura interno/esterno.

TRATTAMENTI



TRATTAMENTO ANTIGOCCIA
Cristalli sempre brillanti, facili da pulire.
Impedisce la formazione del calcare e dei batteri.
Solo su vetri trasparenti.



FINITURA CROMO E ORO PVD
Ciclo di produzione integrata a zero emissioni, 100% ecologico. Anticalcare, resistente all'azione batterica, ecologica brillantezza resistente nel tempo.

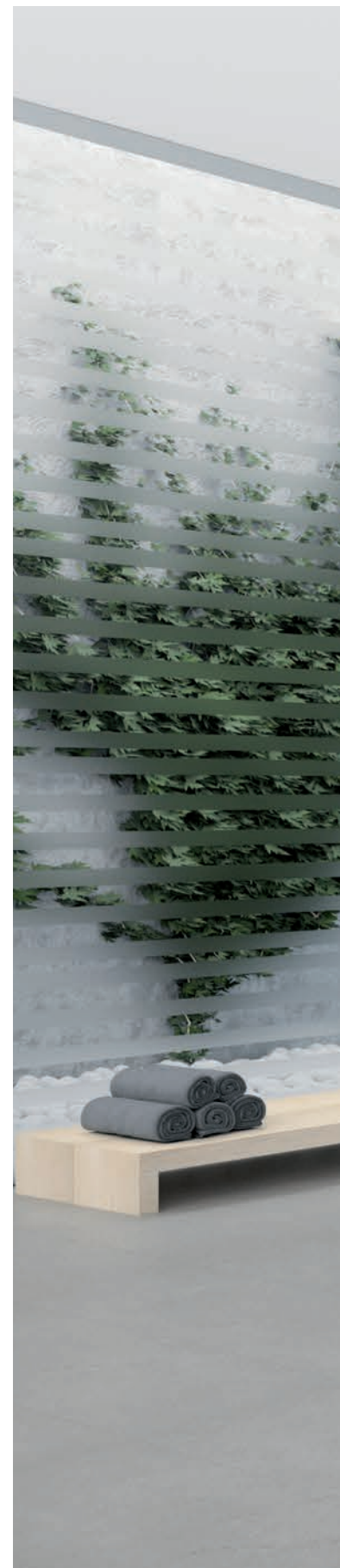

YOUNG 2.0 **G+F** IN LINEA

PORTA DOCCIA, APERTURA 1 ANTA BATTENTE E 1 FISSO IN LINEA

Installabile in nicchia o abbinabile a fisso laterale YOUNG 2.0 F1B

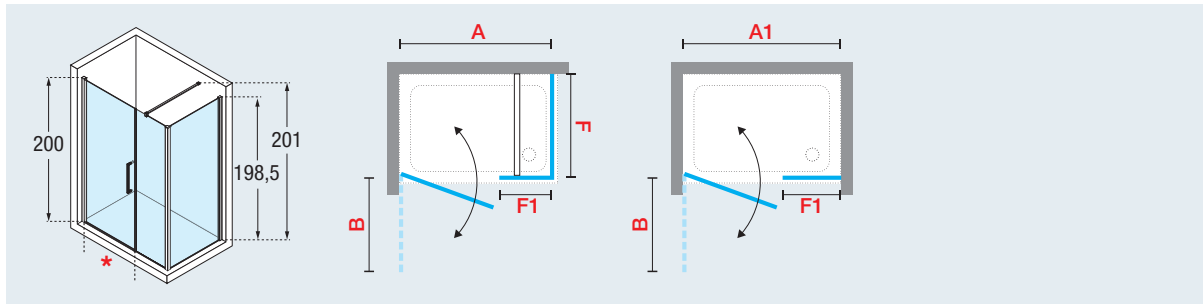

Misure					Codice	Scelta Vetro			Scelta Profilo / Prezzo			
Misura effettiva d'ingombro		Fisso in linea	Entrata	Ingombro anta esterna		1	2	4	D	B	K	O
Con fisso	In nicchia											

PORTA

A	A1	F1	*	B	Codice	Trasparente	Aqua	Satin	Bianco	Silver	Cromo	Oro
98 ↔ 102	97 ↔ 101	32,5	58	59	Y2 GFL 97-	●				■	■	
115 ↔ 119	114 ↔ 118	39,5	68	69	Y2 GFL 114-	●				■	■	
118 ↔ 122	117 ↔ 121	42,5	68	69	Y2 GFL 117-	●				■	■	
138 ↔ 142	137 ↔ 141	52,5	78	79	Y2 GFL 137-	●				■	■	
148 ↔ 152	147 ↔ 151	52,5	88	89	Y2 GFL 147-	●				■	■	
158 ↔ 162	157 ↔ 161	62,5	88	89	Y2 GFL 157-							
168 ↔ 172	167 ↔ 171	72,5	88	89	Y2 GFL 167-							
178 ↔ 182	177 ↔ 181	82,5	88	89	Y2 GFL 177-							
H 140 ↓ 200 L 97 ↔ 177					SPECIAL	Y2 GFL SP						

FISSO

F					Codice	Trasparente	Aqua	Satin	Bianco	Silver	Cromo	Oro
57 ↔ 59	-	-	-	-	Y2 F1B 57-							
59 ↔ 61	-	-	-	-	Y2 F1B 59-							
65 ↔ 67	-	-	-	-	Y2 F1B 65-							
67 ↔ 69	-	-	-	-	Y2 F1B 67-	●				■	■	
69 ↔ 71	-	-	-	-	Y2 F1B 69-							
73 ↔ 75	-	-	-	-	Y2 F1B 73-							
75 ↔ 77	-	-	-	-	Y2 F1B 75-							
77 ↔ 79	-	-	-	-	Y2 F1B 77-	●				■	■	
79 ↔ 81	-	-	-	-	Y2 F1B 79-							
85 ↔ 87	-	-	-	-	Y2 F1B 85-							
87 ↔ 89	-	-	-	-	Y2 F1B 87-	●				■	■	
89 ↔ 91	-	-	-	-	Y2 F1B 89-	●				■	■	
95 ↔ 97	-	-	-	-	Y2 F1B 95-							
97 ↔ 99	-	-	-	-	Y2 F1B 97-	●				■	■	
99 ↔ 101	-	-	-	-	Y2 F1B 99-							
117 ↔ 119	-	-	-	-	Y2 F1B 117-							
119 ↔ 121	-	-	-	-	Y2 F1B 119-							
* H 140 ↓ 200 L 20 ↔ 120					SPECIAL	Y2 F1B SP						

ESEMPIO COMPILAZIONE CODICE:

Y2GFL97-1D = Y2GFL97- + 1 + D

Barra di sostegno 100 cm in dotazione.

OPTIONAL: barra di sostegno 150 cm (vedi pag. 78)

* Il fisso speciale deve essere ordinato della stessa altezza totale della porta

● Disponibilità indicativa deposito centrale 7gg.





200 cm



6 mm



porta 4 cm
fisso 2 cm



p. 79



APERTURA INTERNO-ESTERNO





OPTIONAL



Barra di sostegno ad angolo

Misure	Codice	Prezzo	
		cromo	oro
15 cm	R80LOU150-	K	O
25 cm	R80LOU250-		
35 cm	R80LOU350-		
45 cm	R80LOU450-		



Barra di sostegno 150 cm

Finitura	Codice	Prezzo
bianco	R80Y215-D	
silver	R80Y215-B	
cromo	R80Y215-K	
oro	R80Y215-O	



Kit barra orientabile

- 1 barra orientabile da 100 cm (accorciabile)
- 1 attacco a muro
- 1 morsetto di fissaggio al vetro

Finitura	Codice	Prezzo
Bianco	R80KUOR100-D	
Silver	R80KUOR100-B	
Cromo	R80KUOR100-K	



Kit barra a "T"

barra di sostegno 150 cm da abbinare alla barra in dotazione per soluzione a T

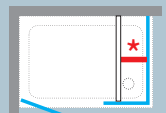

Finitura	Codice	Prezzo
bianco	R80Y215T-D	
silver	R80Y215T-B	
cromo	R80Y215T-K	
oro	R80Y215T-O	

DATI TECNICI

VETRO TEMPRATO 6 mm (European standards UNI EN 14428)

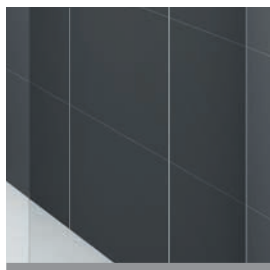

trasparente
COD. 1



aqua
COD. 2



satin
COD. 4

SERIGRAFIA

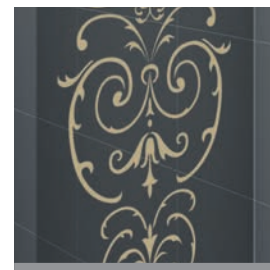

victoriana oro
(vernice dorata)
COD. 72

(solo per i modelli 2G, G+F,
1B, R2 LUX)

FINITURA PROFILI



bianco
COD. D



silver
COD. B



cromo
COD. K

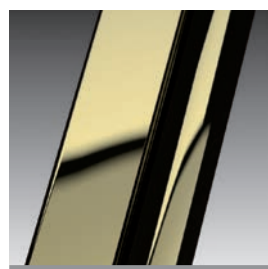

oro
COD. O



(solo per i modelli 2G, G+F, 2A,
2B, F2B, G+F in linea, 1B, F1B,
A, R, R2, R1 SWIM, R2 LUX)

MANIGLIA



maniglia in metallo
cromato.
interasse 384mm

MISURE DI INGOMBRO PROFILI DI FISSAGGIO

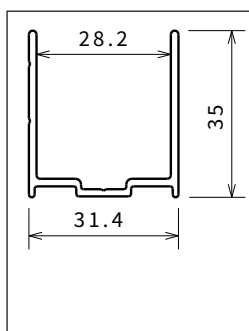

a muro

Altezza	Finitura	Codice
1984	Bianco	P01BNMOBST-A
1984	Silver	P01BNMOBST-B
1984	Cromo	P01BNMOBST-K
1984	Oro	P01BNMOBST-O
2000	Bianco	P01BNMOAST-A
2000	Silver	P01BNMOAST-B
2000	Cromo	P01BNMOAST-K
2000	Oro	P01BNMOAST-O

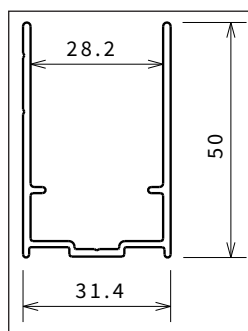

compensativi

Altezza	Finitura	Codice
1984	Bianco	P05Y2ST-A
1984	Silver	P05Y2ST-B
1984	Cromo	P05Y2ST-K
1984	Oro	P05Y2ST-O
2000	Bianco	P05Y2ST2-A
2000	Silver	P05Y2ST2-B
2000	Cromo	P05Y2ST2-K
2000	Oro	P05Y2ST2-O

Per ulteriori informazioni sui profili, vedi pag. 332

COME RILEVARE LE MISURE

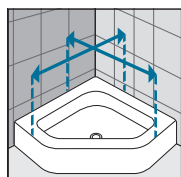
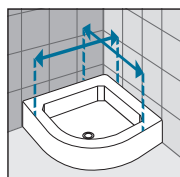
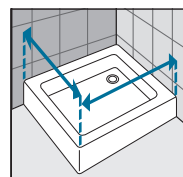

Rilevare le misure da muro a bordo esterno del piatto doccia. Le misure devono essere rilevate sulla parete finita, a rivestimenti posati, secondo gli schemi riportati.

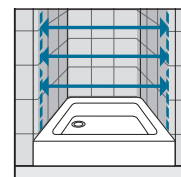

Rilevare le misure da muro a muro, in basso, in alto, al centro e utilizzare quella di valore inferiore. Le misure devono essere rilevate sulla parete finita, a rivestimenti posati, secondo gli schemi riportati.