

BOCCHETTONE AD ANGOLO - PARAFOGGLIE IN PLASTICA

ANGLE PIPE UNION W/SQUARED DISCHARGE - PLASTIC ANTI LEAF 

RACCORD DE DÉCHARGEMENT AVEC SORTIE CARRÉE - PARAFEUILLES EN PLASTIQUE 

BOCA ANGULAR - PARA HOJAS DE PLÁSTICO 

Materiale: Ricetta di Elastomero termoplastico TPV
Material: Thermoplastic elastomer TPV
Matériel: Elastomère thermoplastique TPV



BOCCHETTONE AD ANGOLO USCITA QUADRA
B010x10-01

RACCORDO ANGOLARE
RA08-01
RA10-01



PARAFOGGLIE IN PLASTICA
PF60/150-01





Materiale: PE HD Nero
Material: Black HD PE
Matériel: PE HD noir





BOCCHETTONE AD ANGOLO USCITA TONDA
B008-03
B010-02
B011-02
B012-02

 Prodotto da GRUPPO STAMPLAST in Elastomero termoplastico TPV questo articolo permette lo scarico di acque pluviali dalle superfici piane dotate di muri perimetrali formanti angoli a 90°.

 Manufactured by GRUPPO STAMPLAST in Thermoplastic elastomer TPV allows the drainpipe of rain waters from flat surfaces with walls perimeter forming angles of 90°.









 Produit par GRUPPO STAMPLAST en elastomère thermoplastique TPV cet article permet le déchargement des eaux pluviales des surfaces plates dotées de murs d'enceinte formant angles à 90°.

 Prodotto da GRUPPO STAMPLAST. Il parafoglie è prodotto in PE HD Nero ed è la soluzione ideale nell'impedire l'occlusione degli scarichi pluviali causata da foglie o detriti di altro genere.

 Manufactured by GRUPPO STAMPLAST. The leaf guard is manufactured in HD PE and is the solution in preventing clogging water drains caused by leaves or other general debris.

 Produit par GRUPPO STAMPLAST. Le pare-feuilles est produit en PE HD. Solution idéale pour empêcher l'occlusion des déchargements pluviaux causée par feuilles ou débris d'autre genre.

scheda ordine prodotto

Codice	Mod.	Colore	Conf.	Banc.	Dim. Bancale*	Peso
BO10X10-01	100x100		12	120	100x120x225	0,566 kg/pz
BO08-03	Ad angolo Ø80		16	320	100x120x225	0,406 kg/pz
BO10-02	Ad angolo Ø100		12	240	100x120x225	0,470 kg/pz
BO11-02	Ad angolo Ø110		10	200	100x120x225	0,524 kg/pz
BO12-02	Ad angolo Ø120		10	200	100x120x225	0,558 kg/pz
RA08-01	Raccordo angolare Ø80		10	800	100x120x225	0,160 kg/pz
RA10-01	Raccordo angolare Ø100		10	800	80x120x230	0,161 kg/pz
PF60/150-01	Parafoglie Ø60÷Ø120		150	3600	100x120x210	0,046 kg/pz

*misure in centimetri

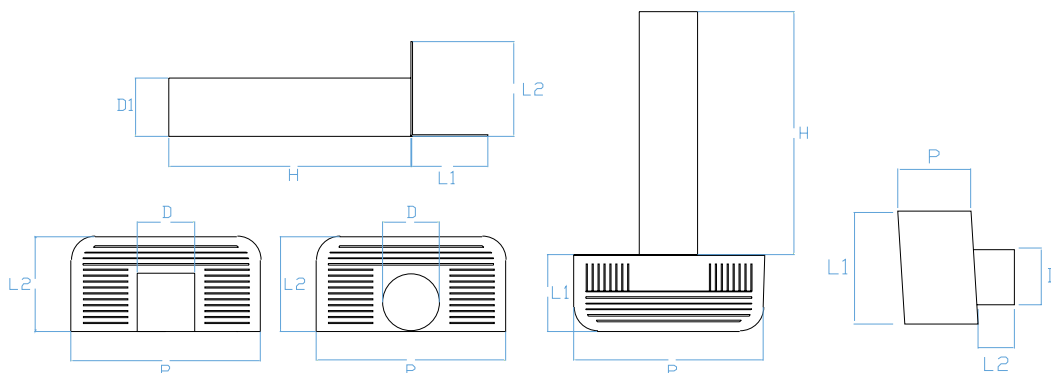

scheda tecnica prodotto

Mod.	USCITA	P*	D*	D1*	L1*	L2*	H*
100x100	Quadra	32	9	10	13	16	41,5
Ad angolo Ø80	Tonda	32	7,5	8	13	16	41,5
Ad angolo Ø100	Tonda	32	9,5	10	13	16	41,5
Ad angolo Ø110	Tonda	32	10	11	13	16	41,5
Ad angolo Ø120	Tonda	32	11	12	13	16	41,5
Raccordo angolare Ø80	--	10,5	7,5	--	14,5	--	--
Raccordo angolare Ø100	--	10,5	9,5	--	14,5	--	--
Parafoglie Ø60÷Ø120	--	14,5	--	--	15,5	5	--

*misure in centimetri

N.B. I pesi indicati possono essere soggetti a variazione del +/- 10% - The weights are subject to change of +/- 10%